

# **RCA**

## **video cassette recorder user's guide**

VR525

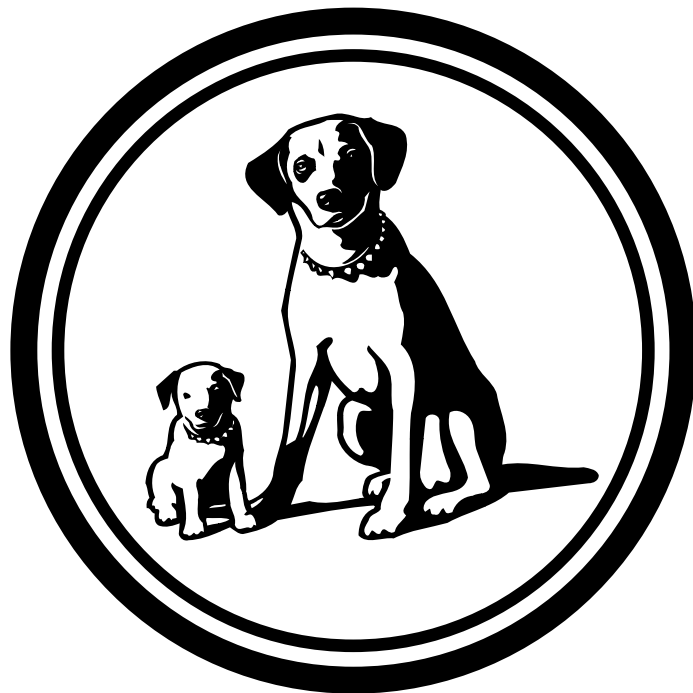

# IMPORTANT INFORMATION

## WARNING

RISK OF ELECTRIC SHOCK DO NOT OPEN

To reduce the risk of electric shock, do not remove cover (or back). No user serviceable parts inside. Refer servicing to qualified service personnel.



This symbol indicates "dangerous voltage" inside the product that presents a risk of electric shock or personal injury.



This symbol indicates important instructions accompanying the product.

## WARNING

To reduce the risk of fire or shock hazard, do not expose this product to rain or moisture.

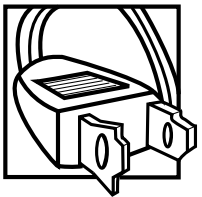

**Caution:** To reduce the risk of electric shock, match wide blade of plug to wide slot, fully insert.

**Attention:** Pour éviter les chocs électriques, introduire la lame la plus large de la fiche dans la borne correspondante de la prise et pousser jusqu'au fond.

Refer to the identification/rating label located on the back panel of your product for its proper operating voltage.

FCC Regulations state that unauthorized changes or modifications to this equipment may void the user's authority to operate it.

**Cable TV Installer:** This reminder is provided to call your attention to Article 820-40 of the National Electrical Code (Section 54 of the Canadian Electrical Code, Part 1) which provides guidelines for proper grounding and, in particular, specifies that the cable ground shall be connected to the grounding system of the building as close to the point of cable entry as practical.

## Product Registration

Please fill out the product registration card and return it immediately. Returning this card allows us to contact you if needed.

Keep your sales receipt to obtain warranty parts and service and for proof of purchase. Attach it here and record the serial and model numbers in case you need them. The numbers are located on the back of the product.

Model No. **VR525** \_\_\_\_\_

Serial No. \_\_\_\_\_

Purchase Date: \_\_\_\_\_

Dealer/Address/Phone: \_\_\_\_\_

\_\_\_\_\_

# TABLE OF CONTENTS

<b>First Things First</b> .....	<b>3</b>
<b>Setting Up the VCR</b> .....	<b>7</b>
Using the Menu to Set up Features .....	8
Language .....	8
VCR Channels List .....	8
To Auto Channel Search .....	9
To Change the Signal Type .....	10
To Add or Remove Channels .....	10
Time and Date .....	10
Set Daylight-Saving Time .....	10
Set the Time and Date .....	11
VCR PLUS+ CHANNELS .....	12
Additional Set-up Features in the Preferences Menu .....	14
Remote VCR1/VCR2 Option .....	14
Auto Play .....	15
Auto TV/VCR .....	15
EnergySaver .....	16
<b>VCR Basics</b> .....	<b>17</b>
Remote Buttons .....	18
Playing a Tape .....	19
Automatic Rewind .....	20
Tape Eject .....	20
Recording .....	20
Check the Safety Tab .....	20
<b>Recording</b> .....	<b>21</b>
Recording Features .....	22
Express Recording (XPR) .....	22
Timer Recording .....	23
Timer Recording with VCR Plus+ .....	24
Setting Up the Channel List .....	24
Using VCR Plus+ .....	24
Stopping a Timer Recording .....	26
Reviewing and Clearing Programs .....	26
Using Two VCRs for Copying and Editing Tapes .....	27
<b>Other Features</b> .....	<b>29</b>
Picture Search Options .....	30
Forward and Reverse Search .....	30
Slow Motion .....	30

# TABLE OF CONTENTS

Commercial Scan (SEARCH BUTTON) .....	30
Frame Advance .....	31
Go-To Search .....	31
Index Search .....	31
Pro-Tect Plus™ Locking Feature .....	32
Tracking .....	32
Time Counter .....	33
On-Screen Displays .....	33
<b>Connections .....</b>	<b>35</b>
Things to Know Before Connecting Components .....	35
Connecting Your VCR .....	36
Jacks and Cables .....	36
Choosing a VCR Connection .....	37
Advantages of Audio/Video Cable Connections .....	37
Don't Forget about the AUTO TV/VCR Feature .....	37
TV with RF jack only .....	38
TV with Audio/Video Jacks .....	39
TV with audio/Video Jacks and Cable Box to Unscramble Pay Channels Only .....	40
<b>Appendix: Reference .....</b>	<b>41</b>
Front Panel .....	42
Indicator Panel .....	43
Back Panel .....	43
Troubleshooting Tips .....	44
Specifications .....	47
Cleaning the VCR .....	47
Limited Warranty .....	48
<b>Index .....</b>	<b>49</b>

# FIRST THINGS FIRST

## HI, MY NAME IS LIZ...

and I wrote this User's Guide. It's my job to see that you have a rewarding user manual experience. You'll find that I've arranged this manual to clearly explain all of your VCR's features.

## READ THE FIRST THREE SECTIONS

The first three sections of the manual introduce you to your VCR, and show you how to set the VCR up and use the on-screen menus. Reading these sections gives you the basic information you need to use your VCR.

## WHAT'S LEFT?

The rest of the book highlights playback and recording information, contains a detailed connections section, and a reference section that includes troubleshooting tips, limited warranty, and index.

## 1 FIRST THINGS FIRST



## 2 SETTING UP THE VCR



## 3 VCR BASICS



## 4 RECORDING



## 5 OTHER FEATURES



## 6 CONNECTIONS

### READ ME!

These note boxes give you tips for your new video cassette recorder.

# FIRST THINGS FIRST

## STEP 1: UNPACK WHAT'S IN THE BOX

The following items come packed in the box:

- VCR
- Remote control
- RF coaxial cable

## STEP 2: INSTALL BATTERIES IN THE REMOTE CONTROL

Follow these steps whenever you need to install or change the batteries in your VCR remote.

1. Remove the cover of the battery compartment.
2. Place the batteries in the remote, matching the + and – ends of each battery to the diagram inside the compartment.
3. Replace the cover.

## STEP 3: CONNECT YOUR VCR

If you connect your VCR to your home antenna or cable system and then to your TV, use the VCR's ANT. IN and RF OUT jacks for a good signal as shown.

If you have a TV with AUDIO/VIDEO jacks, use the jacks for a better connection. Refer to the *Connections* section, toward the back of the manual.

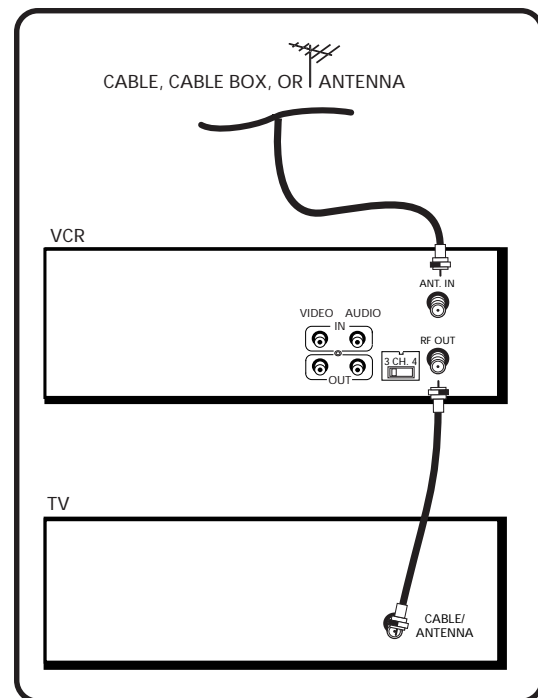

# FIRST THINGS FIRST

## STEP 4: PLUG IN THE VCR

Match the wide blade of the plug with the wide slot in the outlet. Be sure to insert the plug completely.

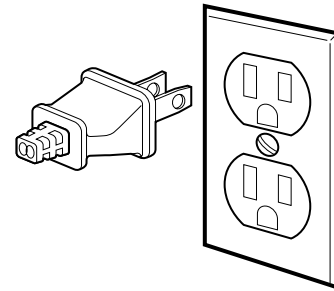

## STEP 5: TUNE THE TV

Tune the TV to the VCR viewing channel. The VCR viewing channel is channel 3 or 4 or the TV's video input.

- If you connect your VCR using the ANTENNA connectors with RF coaxial cable, set the 3 CH. 4 switch to channel 3 or channel 4 — the channel you want to use on your TV.
- If you connect your VCR using the AUDIO/VIDEO jacks with audio/video cables, select the TV's video input to see the signal. See the *TV Owner's Manual*.

## STEP 6: TURN ON THE VCR

Press POWER to turn on the VCR.

## STEP 7: ACCESS THE MENUS

The MENU and number buttons let you access, select and change menu items. For example, to change the Auto Play setting, you would do the following:

### VCR Viewing Channel

When using the ANT. IN and RF OUT jacks to connect your VCR, tune your TV to channel 3 or 4.

When using the AUDIO/VIDEO jacks to connect your VCR, tune your TV to the TV's video input.

# FIRST THINGS FIRST

1. Press MENU to display the VCR MAIN MENU.

```
VCR MAIN MENU
1 VCR Plus+
2 Timer Recordings
3 Time
4 Channels
5 Preferences
6 Language

0 Exit
```

2. Press 5 to display the PREFERENCES menu.

```
PREFERENCES
1 Remote Control: VCR1
2 Auto Play: ON
3 Auto TV/VCR: ON
4 EnergySaver: 2:00

0 Exit
```

3. Press 2 to switch Auto Play to ON or OFF.

```
PREFERENCES
1 Remote Control: VCR1
2 Auto Play: OFF
3 Auto TV/VCR: ON
4 EnergySaver: 2:00

0 Exit
```

See *Additional Set-Up Features* for detailed information about the Auto Play feature.

## STEP 8: SET UP THE VCR

Once you understand how to move around through the menus, go to the next section to set up your VCR.



# SETTING UP THE VCR

## ON-SCREEN GUIDE AND ADDITIONAL SET-UP FEATURES

Below is a list of set-up features that you may want to set up before you begin using your VCR for the first time.

- Select a Language
- Set up VCR Channel List (Auto Channel Search)
- Set Time and Date
- Set up VCR Plus+ Channels
- Set the Remote VCR1/VCR2 feature
- Set the Auto Play feature
- Set the Auto TV/VCR feature
- Set the EnergySaver feature

## 1 FIRST THINGS FIRST



## 2 SETTING UP THE VCR



## 3 VCR BASICS



## 4 RECORDING



## 5 OTHER FEATURES



## 6 CONNECTIONS

# SETTING UP THE VCR

## USING THE MENU TO SET UP FEATURES

You can set up features by using the menu system. Each feature is explained in this section.

### LANGUAGE

Select your preferred language, and the on-screen displays will appear in that language.

1. Press MENU to display the VCR MAIN MENU.

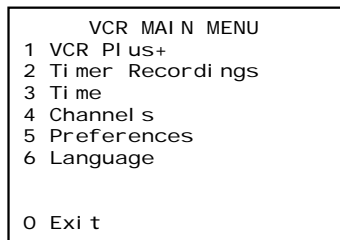

2. Press 6 to select the LANGUAGE menu.

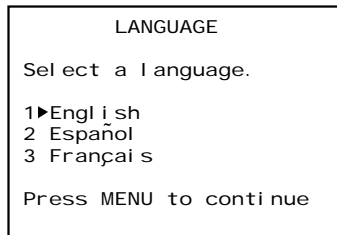

3. Select English, Español (Spanish), or Français (French).

### VCR CHANNELS LIST

If you use a cable box for *all channels*, this step is not necessary. Your VCR may come with a channel list preset at the factory. Even though your VCR may come with a list, it's possible that you may want to add or eliminate some channels depending on whether they are active.

#### On-Screen Menus

Not all the VCR screens are shown in this manual when explaining the features.

# SETTING UP THE VCR

## To Auto Channel Search

1. Press MENU to display the VCR MAIN MENU.

```
VCR MAIN MENU
1 VCR Plus+
2 Timer Recordings
3 Time
4 Channels
5 Preferences
6 Language

0 Exit
```

2. Press 4 to display the CHANNELS menu.

```
CHANNELS
1 Auto Channel Search
2 Add/Remove Channels
3 Signal Type: CABLE
4 VCR Plus+ Channel List

0 Exit
```

3. Press 1 to display the AUTO CHANNEL SEARCH menu.

```
AUTO CHANNEL SEARCH
What type of signal
are you using?
1 Cable TV
2 Antenna
3>Detect Automatically

0 Cancel
```

4. Select one of the three AUTO CHANNEL SEARCH options.

Choices one and two are self-explanatory. If you choose Detect Automatically, the VCR automatically detects which signal system you have attached to your VCR.

```
AUTO CHANNEL SEARCH

Now scanning channel 14

Press any key to cancel
```

The VCR begins scanning for the available channels--this takes about one to two minutes. The lowest channel is tuned once the search is complete. Now pressing CHAN up or down should only select the active channels.

### Auto Channel Search

Use the Auto Channel Search feature to place all available channels in memory.

If you ever change cable or antenna signals, you may need to Auto Channel Search again.

### Detect Automatically

A strong cable or antenna signal in your area may cause Auto Detect to mis-detect. If this should happen, select 1 or 2 for the system you have.

# SETTING UP THE VCR

## To Change the Signal Type

1. Press MENU to display the VCR MAIN MENU.
2. Press 4 to display the CHANNELS menu.
3. Press 3 to change the Signal Type between CABLE and ANTENNA.

## To Add or Remove Channels

You may want to add or remove channels after you Auto Channel Search, especially if some of the channels have weak signals or you don't want to watch them.

1. Press MENU to display the VCR MAIN MENU.
2. Press 4 to display the CHANNELS menu.
3. Press 2 to display the ADD/REMOVE CHANNELS screen. Use CHAN up or down or number buttons to go to the channels you want to remove or add.

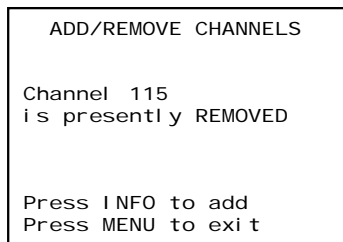
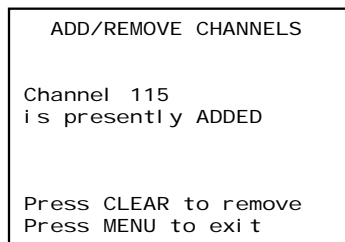

## TIME AND DATE

Before you set the time and date, set the Auto DST (Daylight-Saving Time) feature to ON or OFF for your area.

## Set Daylight-Saving Time

1. Press MENU to display the VCR MAIN MENU.

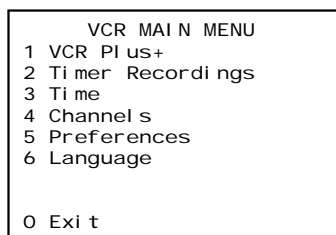

### Selecting Channels

The CHANNEL up and down buttons access those channels active in your VCR channel list.

You can still access channels not in the channel list by using the number buttons on the remote.

# SETTING UP THE VCR

2. Press 3 to display the TIME menu.

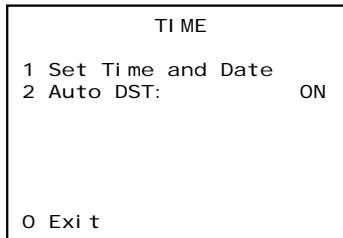

3. Press 2 to turn Auto DST: ON or OFF.
  - Select ON if you want the VCR's clock to automatically adjust for daylight-saving time.
  - Select OFF if you do not want the VCR's clock to adjust for daylight-saving time.

## Set the Time and Date

1. Press MENU to display the VCR MAIN MENU.
2. Press 3 to display the TIME menu.
3. Press 1 to display the SET TIME AND DATE menu.

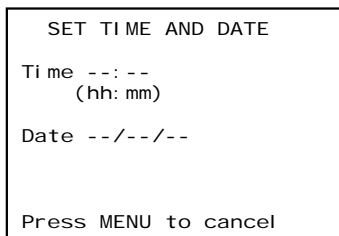

4. Enter the data using the number buttons. Press 0 before single-digit numbers and follow the on-screen directions.

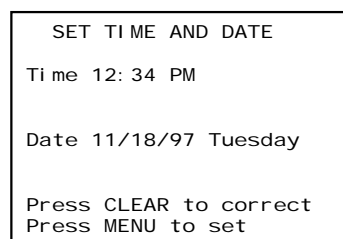

### Spring forward; Fall backward

In the Spring, daylight-saving time begins on the first Sunday in April. Because the clock automatically changes from 2:00 AM to 3:00 AM (forward one hour), remember to include the extra hour for timer recording falling within this time frame.

In the Autumn, daylight-saving time ends on the last Sunday in October. The VCR clock automatically changes from 2:00 AM to 1:00 AM (back one hour). Therefore, it can affect your recording length.

### Time/Date Display

Pressing INFO on the remote displays the time and date on the screen.

# SETTING UP THE VCR

## VCR PLUS+ CHANNELS

Using VCR Plus+ can make programming timer recordings for cable or off-air antenna easier, but you have to put in a little time right now to set up a channel list. A worksheet and abbreviated codes for typical cable services in the U.S. and Canada are provided.

1. Press MENU to display the VCR MAIN MENU.

```

VCR MAIN MENU
1 VCR Plus+
2 Timer Recordings
3 Time
4 Channels
5 Preferences
6 Language

0 Exit
    
```

2. Press 4 to display the CHANNELS menu.

```

CHANNELS
1 Auto Channel Search
2 Add/Remove Channels
3 Signal Type: CABLE
4 VCR Plus+ Channel List

0 Exit
    
```

3. Press 4 to display the VCR Plus+ Channel List screen.

```

VCR+ Channel My Channel
5          --
4          --
3 -> -> -> --
2          --
1          --

Use CH+/- to select
Press 0-9 to change
Press MENU to save
    
```

4. Enter the data following the on-screen directions using your worksheet.

```

VCR+ Channel My Channel
5          46
4          --
3 -> -> -> 23
2          --
1          --

Use CH+/- to select
Press 0-9 to change
Press MENU to save
    
```

### Two-Digit VCR Plus+ Channel Numbers for Cable TV (USA List)

- 35 American Movie Classics
- 39 Arts &-Entertainment
- 57 Black Entertainment
- 54 Bravo
- 42 Cable News Network
- 45 Cinemax
- 98 Cinemax 2
- 37 The Discovery Channel
- 53 The Disney Channel
- 63 Entertainment Television
- 34 ESPN Sports Network
- 47 The Family Channel
- 33 Home Box Office
- 95 Home Box Office 2
- 96 Home Box Office 3
- 51 The Learning Channel
- 46 Lifetime
- 58 The Movie Channel
- 48 Music Television
- 49 The Nashville Network
- 38 Nickelodeon
- 64 Nostalgia Television
- 99 Quality Value Cable
- 41 Showtime
- 97 Showtime 2
- 59 Sports Channel
- 52 Turner Network Television
- 44 USA-Network
- 62 Video Hits 1
- 93 Viewer's Choice 1
- 94 Viewer's Choice 2
- 55 WGN Chicago
- 43 WTBS Atlanta
- 60 WWOR-New York

*See next page for Canadian List*

### VCR Plus+ Channel List

Refer to your local television list for a complete VCR Plus+ channel list for your viewing area or contact your cable company. Using the list may save you some time.



# SETTING UP THE VCR

## ADDITIONAL SET-UP FEATURES IN THE PREFERENCES MENU

The features in this section are all accessed through the PREFERENCES menu.

1. Press MENU to display the VCR MAIN MENU.

```
VCR MAIN MENU
1 VCR Plus+
2 Timer Recordings
3 Time
4 Channels
5 Preferences
6 Language

0 Exit
```

2. Press 5 to display the PREFERENCES menu.

```
PREFERENCES
1 Remote Control: VCR1
2 Auto Play: ON
3 Auto TV/VCR: ON
4 EnergySaver: 2:00

0 Exit
```

Now you are ready to select an item from the menu to set up.

## REMOTE VCR1/VCR2 OPTION

If you own a compatible RCA, GE, or ProScan remote that has a VCR2, VCR2•LD, or VCR2•DVD button, this feature allows you to set this VCR to respond to that button.

Press 1 to select the Remote Control item. Then press the VCR2, VCR2•LD, or VCR2•DVD button to change.

```
PREFERENCES
(Press VCR2 to Change)
2 Auto Play: OFF
3 Auto TV/VCR: OFF
4 EnergySaver: 2:00

0 Exit
```

```
PREFERENCES
1 Remote Control: VCR2
2 Auto Play: OFF
3 Auto TV/VCR: OFF
4 EnergySaver: 2:00

0 Exit
```

### Remote Control Option

Changing the remote option to VCR2 disables the remote that came with your VCR.



# SETTING UP THE VCR

The VCR will only respond to the compatible remote's VCR2, VCR2•LD, or VCR2•DVD button. If you change the remote setting to VCR2, the remote that came with your VCR will no longer control it.

Use the compatible remote to change the remote setting back to VCR1. Display the PREFERENCES menu, press 1, and then press VCR on the VCR's remote.

## AUTO PLAY

This feature allows the VCR to automatically start playing when you insert a tape with the safety tab removed. Press 2 to switch between ON or OFF.

- Select ON if you want a tape with its safety tab removed to start playing automatically when the tape is inserted.
- Select OFF if you *do not* want a tape with its safety tab removed to start playing automatically.

## AUTO TV/VCR

This feature controls whether the TV/VCR switch changes automatically to the VCR mode. Press 3 to switch between ON and OFF.

- Select ON if you want the VCR to switch to the VCR mode when the VCR is turned on or a cassette is inserted. *This only applies if you connect the ANT. IN and RF OUT jacks of your VCR and TV and watch your VCR on channel 3 or 4 of your TV.*
- Select OFF if you want the VCR to remain in the TV mode. This is useful if you watch your VCR on the TV's video input and you don't want your antenna/cable signal interrupted by the VCR. Refer to the Connections section, toward the back of the manual.

### Auto TV/VCR

Pressing TV•VCR will still switch between the VCR and TV mode.

VCR mode: VCR indicator in the display panel lights.

TV mode: VCR indicator turns off.

# SETTING UP THE VCR

## ENERGYSAVER

By default, this VCR automatically turns off after two hours of inactivity. Press 4 to change the time delay, or to disable the feature.

- OFF: The VCR will remain turned on until you shut it off.
- 1:00, 2:00, or 3:00: The VCR turns off after one, two, or three hours of inactivity.

Thirty seconds before shutting off, the VCR will warn you with a screen reading, "The VCR will turn off in 30 seconds. Press any key to cancel."

If you use the VCR's tuner instead of your TV to tune channels, you may want to turn this feature off.

# VCR BASICS

## LEARN THE BASICS TO GET YOU STARTED

These VCR basics should be enough for you to begin enjoying your VCR. Learning the remote control functions, playing a recorded tape, and recording a program should do just that.

However, there are other features that enhance the enjoyment of your VCR, but they aren't necessary to get you started. If you want to learn more about your VCR, just keep reading.

**1** FIRST THINGS FIRST



**2** SETTING UP THE VCR



**3** VCR BASICS



**4** RECORDING



**5** OTHER FEATURES



**6** CONNECTIONS

VCR Basics tells you what you need to know in order to watch a movie or tape your favorite show.

# VCR BASICS

## REMOTE BUTTONS

**CHANNEL Up or Down** Selects next higher or lower channel in the VCR's channel memory.

**CLEAR** Resets time counter to 0:00:00. Allows you to change entries when setting the clock or a timer recording.

**F.ADV** Lets you view one frame with each press of the button when tape is in pause.

**FWD** Fast forwards the tape when the VCR is stopped. Searches forward through a tape during playback. Starts slow motion during play-pause and increases slow-motion speed.

**GO BACK** Switches between two channels. Select one channel and then select another using the number buttons. Press GO BACK to switch between the two channels. In menu mode, press to go back to the previous menu.

**INFO** Shows the status displays on the TV screen.

**INPUT** Selects between the line input and the VCR's tuner. Line input refers to the signal coming from the component connected to the AUDIO/VIDEO IN jacks on the back of the VCR.

**MENU** Brings up VCR MAIN MENU on the TV screen.

**Numbers (0 through 9)** Select a channel up to 99 by pressing two numbers. Select a cable channel over 99 by pressing and holding 1 until 1 -- appears on the screen. Then press the other two numbers.

**PAUSE** Pauses playback or recording. Press PAUSE again to return to playback or recording.

**PLAY** Plays a tape.

**REC** Starts VCR recording. Also used for express recording.

**REV** Rewinds the tape when the VCR is stopped. Searches backward through a tape during playback. Starts slow motion during play-pause and decreases slow-motion speed.

**SEARCH** Displays INDEX and GO-TO Search menus on TV screen when VCR is stopped. Advances the tape 30 seconds of recorded material during playback. Each press advances the tape an additional 30 seconds up to five minutes.

**SLOW** Used for slow-motion playback.

**SPEED** Selects a recording speed (SP or SLP).

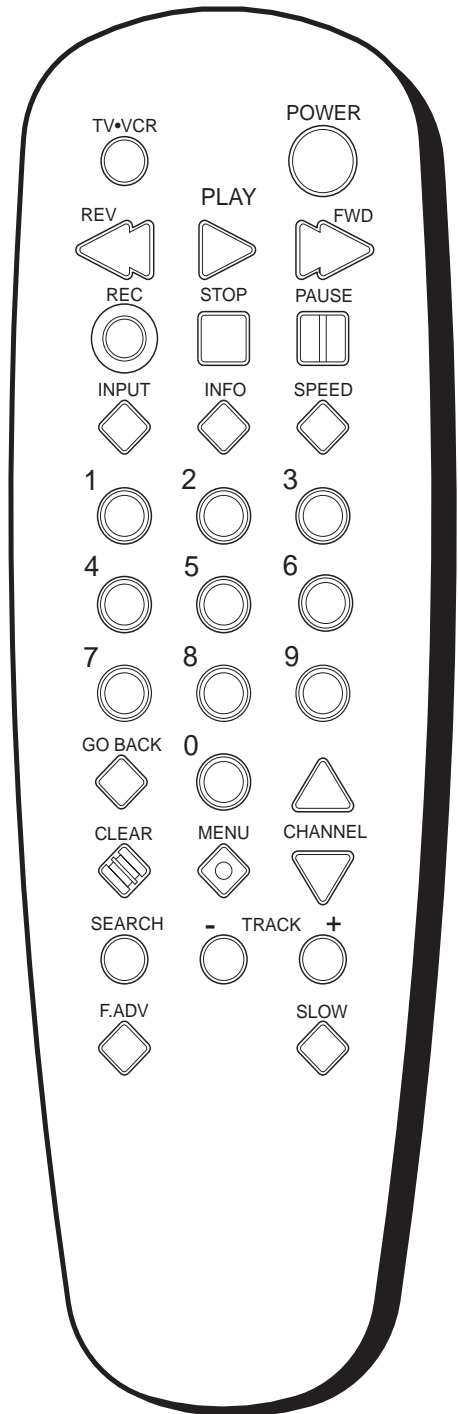

# VCR BASICS

**STOP** Stops the current VCR function such as record, playback, rewind, or fast forward.

**TRACK - or +** Lets you manually reduce the streaks that may appear on the picture during play, slow motion, or pause. Reduces picture "jitter" during stop-action playback.

**TV•VCR** Switches the picture signal so that it either comes from the VCR or cable/antenna system.

## PLAYING A TAPE

1. Tune the TV to your VCR viewing channel (3, 4, or TV's video input).
2. Insert a tape in the VCR.

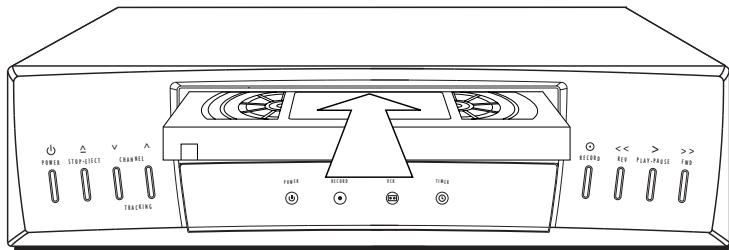

If the Auto Play feature is set to ON, the tape automatically begins playback (if the safety tab on the cassette is removed).

- Press FWD or REV to position the tape.
- Press PLAY•PAUSE (if necessary) on the VCR (PLAY on remote) to begin tape play.
- Press PLAY•PAUSE (PAUSE on remote) for stop action.
- Press TRACK up or down to remove any streaks from the picture, if necessary.
- Press STOP•EJECT on VCR (STOP on remote) to stop playback.

### Pause

If you pause, the VCR automatically switches from pause to stop after a few minutes to reduce tape wear.

### Automatic Tracking

The VCR has automatic tracking which adjusts the picture when playing back a tape recorded on another VCR. Automatic tracking is turned on whenever a tape is inserted or the VCR's power is turned on.

# VCR BASICS

## AUTOMATIC REWIND

The VCR automatically rewinds the tape if it reaches the end of the tape during playback. While rewinding, you can press POWER and the VCR will turn off after rewinding.

## TAPE EJECT

Press STOP•EJECT on the VCR (STOP on remote) when it is stopped to eject the tape. A tape can be ejected even when the VCR is off.

## RECORDING

If you want to record something that you're watching, you can use basic recording.

1. Set the tape speed by pressing the SPEED button on the remote.
2. Press the RECORD button (REC on the remote) to begin recording.
3. Press STOP to stop recording.

If you just want to pause the recording for a short time (such as during a commercial), press PAUSE instead of STOP.

## CHECK THE SAFETY TAB

No matter which recording option you use, you need to make sure there is a tape in the VCR, and that the tape's safety tab is in place. You cannot record on a tape with the safety tab removed.

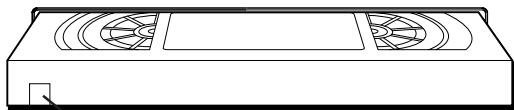

Safety Tab

If the safety tab is removed and you want to record over it, simply cover the hole with vinyl tape.

### Tape Speeds

#### SP (Standard Play)

Gives the best quality recording, but fewer programs can be recorded on the tape. Special effects such as pause, slow motion, picture search, and frame advance work well when you play back tapes recorded in this speed.

#### LP (Long Play)

Your VCR is capable of playing back tapes recorded in LP. You cannot record in the LP speed.

#### SLP (Super Long Play)

Gives three times the recording time of tapes recorded in SP. Special effects such as pause, slow motion, picture search, and frame advance work well when you play back tapes recorded in this speed.

	Recording Time	
Cassette	SP	SLP
T-120	2Hr	6Hr
T-160	2Hr 40Min	8Hr

# RECORDING

## SEVERAL RECORDING OPTIONS

Now that you've gone through the necessary steps to operate your VCR, I'll explain the different recording features that are available to suit your needs.

Recording Features:

- Recording (explained in *VCR Basics* section)
- Express Recording
- Timer Recording
- Timer Recording with VCR Plus+
- Copying and Editing Tapes

**1** FIRST THINGS FIRST



**2** SETTING UP THE VCR



**3** VCR BASICS



**4** RECORDING



**5** OTHER FEATURES



**6** CONNECTIONS

# RECORDING

## RECORDING FEATURES

There are four ways to record programs:

- **Recording** lets you press one button to start recording a program. (See *VCR Basics* section.)
- **Express Recording** lets you start recording a program you are watching, and then set the VCR to automatically stop recording after a designated period of time.
- **Timer Recording** lets you program the VCR to automatically start and stop recording at a predetermined time.
- **Timer Recording with VCR Plus** lets you program the VCR just by entering a PlusCode number found in TV guides.

## EXPRESS RECORDING (XPR)

Use express recording when you want to quickly record the remaining portion of the program you are watching.

1. Set the tape speed by pressing the SPEED button on the remote.
2. Press the RECORD button (REC on the remote) to begin recording.
3. Repeatedly press the RECORD button to set up the recording duration.

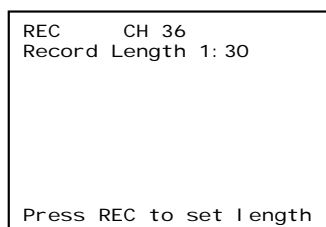
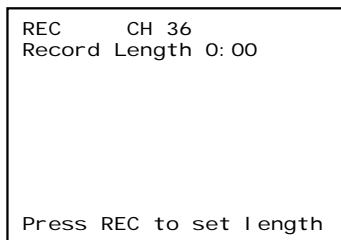

Each time you press the RECORD button, you increase the recording time (up to 4 hours).

The VCR continues to record for the amount of time you indicate, and then automatically turns off.

To stop an express recording, press and hold STOP for a few seconds.

### Express Recording

Express recording is a great way to tape the last quarter of the game, or the last part of a movie when you have to leave.



# RECORDING

## TIMER RECORDING

You can set up as many as eight timer recording programs.

1. Press MENU to display the VCR MAIN MENU.

```
VCR MAIN MENU
1 VCR Plus+
2 Timer Recordings
3 Time
4 Channels
5 Preferences
6 Language

0 Exit
```

2. Press 2 to display the TIMER RECORDINGS menu.

```
TIMER RECORDINGS
1 Create a New Program
2 Review Existing Progs.
3 Use VCR PLUS+ Code

0 Exit
```

3. Select 1 to Create a New Program.

```
How often should this
program record?
1 One time
2 Daily (every day)
3 Weekdays (M-F)
4 Weekly (once per week)

0 Cancel
```

4. Select how often you want the program to record.

```
Program 1 (One time)
Channel --
Start Time ---:--
End Time ---:--
Start Date --/--/--
Tape Speed SLP

Press MENU to cancel
```

### Timer Recording Information

Clock must be set correctly.

Insert a tape with the safety tab in place and enough tape to record the program.

PROGRAMS OVERLAP appears if you have entered two programs where the times overlap.

The TIMER indicator appears in the display when you turn off the VCR and a timer recording has been set. It flashes if there is no tape in the VCR.

When recording from a cable box or satellite receiver, turn it on and tune it to the channel you want to record before the recording is to begin. The VCR channel should be set to the cable box's output channel, usually Channel 3 or 4.

# RECORDING

5. Enter the data for the program with the number buttons.

The data includes the channel number (press INPUT to select the line input), start time including AM or PM, and end time. The start date is automatically entered based on the VCR clock. The date and/or speed can be changed when flashing.

6. Review the information to make sure it is correct, and then press MENU to save.

```
Program 1 (One Time)
Channel      03 Cable
Start Time  08:00 PM
End Time    09:30 PM
Start Date  11/18/97 TUE
Tape Speed  SLP
            1=SP 2=SLP
Press CLEAR to correct
Press MENU to save
```

```
Program 1 has been saved
Remember to insert a
recordable tape and
turn the VCR off before
the program start time.
Press MENU to continue
```

## TIMER RECORDING WITH VCR PLUS+

You can use VCR Plus+ to simplify timer programming if you have cable TV and don't receive all channels through a cable box or if you receive your TV signal off-air.

### Setting Up the Channel List

If you did not set up the VCR Plus+ channel list, you can do it now.

1. Display the CHANNELS menu from the VCR MAIN MENU.
2. Display the VCR Plus+ Channel List menu.
3. Go to *Setting Up Your VCR* if you need more information on setting up your VCR Plus+ channel list.

### Using VCR Plus+

1. Press MENU to bring up the VCR MAIN MENU.

```
VCR MAIN MENU
1 VCR Plus+
2 Timer Recordings
3 Time
4 Channels
5 Preferences
6 Language
0 Exit
```

```
VCR MAIN MENU
1 VCR Plus+
2 Timer Recordings
3 Time
4 Channels

CHANNELS
1 Auto Channel Search
2 Add/Remove Channels
3 Signal Type: CABLE
4 VCR Plus+ Channel List

VCR+ Channel My Channel
5          46
4          --
3 -> -> -> 23
2          --
1          --

Use CH+/- to select
Press 0-9 to change
Press MENU to save
```

If you receive all channels through your cable box on Channel 3 or 4, you must use the regular Timer Recording method to record programs.

# RECORDING

2. Press 1 to display the VCR PLUS+ menu.

```
VCR PLUS+
Enter PlusCode Number
  (from TV listing)
  -
Press MENU to cancel
```

3. Enter the VCR PlusCode shown in your local television programming guide.

```
VCR PLUS+
Enter PlusCode Number
  (from TV listing)
  12876
Press CLEAR to correct
Press MENU when done
```

4. Press MENU to enter the VCR PlusCode number.

```
How often should this
program record?
1 One time
2 Daily (every day)
3 Weekdays (M-F)
4 Weekly (once per week)
0 Cancel
```

5. Indicate how often you want the program to be recorded.

```
Program 1 (One time)
Channel 03 Cable
Start Time 08:00 PM
End Time 09:30 PM
Start Date 10/24/98 SAT
Tape Speed SLP
Press CLEAR to adjust
Press MENU to save
```

6. Change the speed with the SPEED button on the remote or the program end time with the CLEAR button on the remote (if necessary).

Changing the end time comes in handy when you are recording a program, such as a sporting event, that may exceed the scheduled broadcast time.

## VCR Plus+ Recording

Clock must be set correctly.

Insert a tape with the safety tab in place and enough tape to record the program.

The TIMER indicator appears in the display when you turn off the VCR and a timer recording has been set. It flashes if there is no tape in the VCR.

PROGRAMS OVERLAP appears if you have entered two programs where the times overlap.

UNRECOGNIZED NUMBER... PLEASE RE-ENTER appears when the VCR does not recognize the PlusCode number.

Turn on the cable box and tune it to the channel you want to record before the recording is to begin.

Timer recordings will not be lost in the event of an extended power outage.

# RECORDING

7. Press MENU to save the program.

```
Program 1 has been saved  
  
Remember to insert a  
recordable tape and  
turn the VCR off before  
the program start time.  
  
Press MENU to continue
```

## STOPPING A TIMER RECORDING

To stop or cancel a timer recording in progress (even an express recording):

- Press and hold the STOP button for a few seconds.

## REVIEWING AND CLEARING PROGRAMS

To review programs that you have already set up:

1. Press 2 when the VCR MAIN MENU is displayed to display the TIMER RECORDINGS menu.

```
TIMER RECORDINGS  
  
1 Create a New Program  
2 Review Existing Progs.  
3 Use VCR Plus+ Code  
  
0 Exit
```

2. Press 2 to display the Review Existing Progs. screen.

```
Program 1 (One time)  
  
Channel      104 Cable  
Start Time  12:00 AM  
End Time    01:30 AM  
Start Date  10/24/97 FRI  
Tape Speed  SLP  
  
Press CLEAR to erase  
Press MENU for next prog
```

3. Press CLEAR to erase or MENU to see the next program.

# RECORDING

## USING TWO VCRs FOR COPYING AND EDITING TAPES

Use one VCR as the *playback VCR* and the other as the *recording VCR*.

1. Connect the VCRs using the diagram below.
2. Turn on both VCRs and TV.
3. Tune the TV to the VCR viewing channel (either 3, 4, or TV's video input).
4. If you are using coaxial cables for the connection, tune *recording VCR* to channel 3 or 4—the one selected on the *playback VCR*.

If you are using audio/video cables, select the line input on the *recording VCR*.

5. Insert the tape you want to copy into *playback VCR*. Insert a blank tape with its safety tab in place into *recording VCR*.
6. Using visual search, locate the segment you want to copy on the *playback VCR*. Pause the tape at this location.
7. Press RECORD on the *recording VCR*, then PAUSE.
8. Press PAUSE on both VCRs to begin copying.
9. Press PAUSE on both VCRs to stop copying.
10. Repeat steps 6–9 to copy or edit additional segments.

### Caution:

The unauthorized recording of satellite broadcasts, television programs, or other copyrighted materials may infringe the rights of others.

### Two VCR Connection

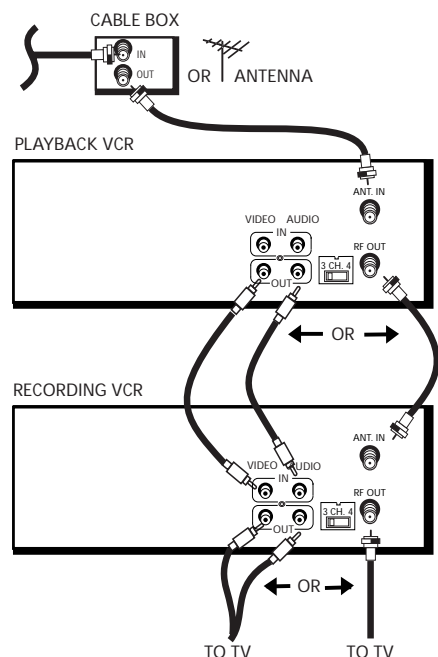



# OTHER FEATURES

## FEATURES TO ENHANCE VCR OPERATION

- Picture Search Options
- Pro-Tect Plus™ Locking
- Tracking
- Time Counter
- On-Screen Displays

**1** FIRST THINGS FIRST



**2** SETTING UP THE VCR



**3** VCR BASICS



**4** RECORDING



**5** OTHER FEATURES



**6** CONNECTIONS

# OTHER FEATURES

## PICTURE SEARCH OPTIONS

The most basic way to search during playback is using the FWD or REV buttons. This section contains several other options available for searching a tape.

### FORWARD AND REVERSE SEARCH

You can search a tape during playback. Sound is turned off during picture search. Search works well for tapes recorded at either the SP or SLP speed.

1. Press FWD to search forward or REV to search in reverse.
2. Press FWD or REV again or press PLAY to return to normal playback.

### SLOW MOTION

You can view a tape during play or play-pause using slow motion. Slow motion works well for tapes recorded at the SP or SLP speed.

1. Press SLOW on the remote to begin slow-motion playback.
2. During playback, press PAUSE and then FWD or REV to begin slow-motion playback.
3. Press FWD to increase or REV to decrease the speed of the search.
4. Use TRACK up or down to remove any streaks from the picture.
5. Press PLAY to return to normal playback. The VCR switches automatically from slow-motion playback to stop after a few minutes.

### COMMERCIAL SCAN (SEARCH BUTTON)

This is useful for skipping commercials or short program segments.

1. Press SEARCH once during playback to advance the tape approximately 30 seconds of recorded material.
2. Each press of the SEARCH button adds an additional 30 seconds up to five minutes.



# OTHER FEATURES

## FRAME ADVANCE

Frame advance lets you view one-stop action frame after another during playback. Frame advance works well for tapes recorded at the SP or SLP speed.

1. Press PAUSE to “freeze” the action.
2. Press F.ADV each time you want to view a frame of the scene.
3. Press PAUSE or PLAY to return to normal playback.

## INDEX SEARCH

The VCR has a “VHS Index Search System” that automatically records an index mark on the tape every time you start a recording.

During playback you can locate the program you want to play by the number of index marks or by scanning. The VCR will search forward or reverse from the location you are on the tape.

### To Search:

1. Press STOP.
2. Press SEARCH on the remote to display the INDEX SEARCH menu on the TV screen.
3. If you want to search through a certain number of index marks, press two number buttons to enter the number of marks you want to search. Press CLEAR on the remote to correct an entry.
4. Press FWD to search forward or REV to search in reverse. The VCR will locate your index mark and begin playback. If you did not enter a specific index number, the VCR will locate the next index mark and begin playback.
5. Press STOP to stop index searching.

Some index marks may be missed by the VCR:

- A mark too close to your location on the tape.
- The mark at the beginning of a recorded segment of five minutes or less.
- The first index mark on the tape when you start at the beginning of the tape.

```
INDEX SEARCH
Press REV OR FWD
to begin scanning
OR
enter a specific
index number
  --
Press SEARCH to exit
```

```
INDEX SEARCH
Searching for
index number 12...
Press STOP to cancel
```

```
INDEX SEARCH
Searching for
index marks...
Press STOP to cancel
```

# OTHER FEATURES

## GO-TO SEARCH

The Go-To Search feature enables the VCR to quickly locate a counter reading anywhere on the tape. When the VCR locates the counter reading, it will begin playback.

1. Press STOP.
2. Press SEARCH on the remote until the GO-TO SEARCH menu appears on the screen.
3. Press number buttons to enter the hour(s) and/or minutes of the counter reading you want the VCR to "go to". Press CLEAR on the remote to correct an entry.
4. Press FWD to search forward or REV to search in reverse.
5. Press STOP to stop Go-To searching.

```
GO-TO SEARCH
Current tape counter is
2:17:25
Press REV or FWD
to go to 0:00:00
Press SEARCH to exit.
```

## PRO-TECT PLUS™ LOCKING FEATURE

To disable the usage of the VCR, or to protect your timer recordings, you can lock the VCR so that the buttons on the VCR or remote won't work.

- To Lock: Press and hold either the remote's POWER or OFF button. The front panel POWER indicator flashes when the feature is activated. POWER will also flash if you attempt to turn on the VCR while the feature is on.
- To Unlock the feature and turn on the VCR: Press and hold either the remote's POWER or VCR button.

### Locking Your VCR:

If a timer recording is programmed, make sure your VCR is turned off. Locking your VCR prevents the VCR from being accidentally turned on.

# OTHER FEATURES

## TRACKING

Your VCR has automatic tracking which removes the streaks or snow from the picture. Automatic tracking is activated when you insert a tape or turn on the VCR. Occasionally you may need to manually adjust tracking, especially if the tape was recorded on a different VCR. Just use the TRACK buttons to remove the streaks or snow. You can also use tracking when you pause a tape to reduce jittering of the picture.

When you manually adjust the picture, automatic tracking is turned off. To turn automatic tracking back on, press both TRACK buttons on the front of the VCR at the same time, or eject the tape and re-insert it. Tracking has no effect during recording – only playback.

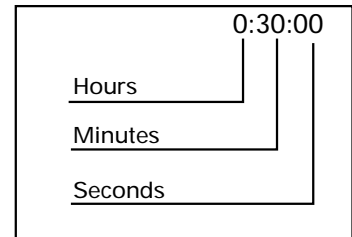

## TIME COUNTER

The time counter shows the actual time it takes to record a program or play back a segment of a recorded tape. It helps locate the beginning or end of programs you taped. The time counter resets to 0:00:00 whenever the tape is ejected from the VCR.

For example, if you record a 30-minute program at the beginning of the tape and you want to go to the end of that program to begin another recording, you would:

1. Press INFO **twice** to display the time counter.
2. Press CLEAR to reset the time counter to 0:00:00.
3. Press FWD to forward the tape until the time counter reads 0:30:00.
4. Press STOP. This is the approximate end of the program. (You may want to press PLAY to verify.) Now, you can begin recording at this spot.
5. Press INFO twice to remove the time counter from the screen and return to the normal display mode.

# OTHER FEATURES

## ON-SCREEN DISPLAYS

The INFO button shows the status of the VCR (STOP, PLAY, RECORD, etc.), channel number, time counter, date, time, and tape speed on the TV screen. The date and time must be set before they can be displayed.

1. Press INFO to see the on-screen displays.
2. Press INFO again to have only the time counter remain on the screen.
3. Press INFO again to have no displays appear on the TV screen. This is useful for dubbing tapes.

Turning off the VCR also resets the displays.

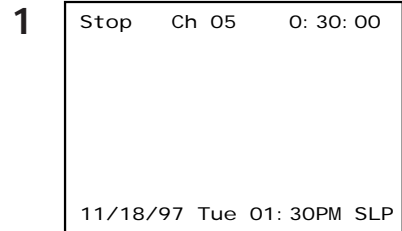

*On-screen display (times out)*

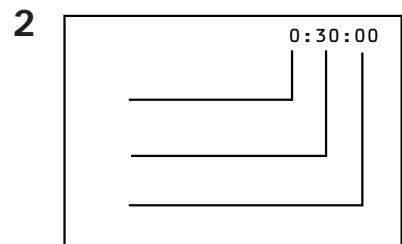

*Time counter only (does not time out)*



*No displays will appear  
(useful for dubbing)*

# CONNECTIONS

## THINGS TO KNOW BEFORE CONNECTING COMPONENTS

### Protect Your Components from Power Surges

- Connect all components before plugging any power cords into the wall outlet.
- Always turn off the TV and other components before you connect or disconnect any cables.

### Position Cables Correctly to Avoid Audio Hum or Interference

- Insert all cable plugs firmly into their jacks.
- Place the audio/video cables to the sides of the TV's back panel instead of straight down the middle after you connect your components.
- Try not to coil any twin-lead cables and keep them away from the audio/video cables as much as possible.
- Make sure all antennas and cables are properly grounded. Refer to the Safety Tips sheet packed with your unit.

### Protect Your Components from Overheating

- Do not block ventilation holes in any of the components. Arrange the components so that air can circulate freely.
- Do not stack components.
- Allow adequate ventilation when placing your components in a stand.
- Place an amplifier or satellite receiver on the top shelf of the stand so heated air rising from it will not flow around other components.

## 1 FIRST THINGS FIRST



## 2 SETTING UP THE VCR



## 3 VCR BASICS



## 4 RECORDING



## 5 PROGRAMMING THE REMOTE



## 6 CONNECTIONS

# CONNECTIONS

## CONNECTING YOUR VCR

Refer to these pages to help you connect your VCR.

### JACKS AND CABLES

#### RF Jacks and Coaxial Cables (F-type)

The RF jacks provide good picture and mono sound quality, and must be used if audio/video connections are not available for your TV.

These jacks are required for antenna or cable-TV connections. The RF jacks on the VCR are labeled ANT. IN and RF OUT. The coaxial cable supplied with your VCR is used to connect the VCR's RF OUT jack and your TV's antenna input.



RF Jack

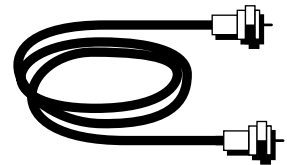

#### Audio/Video Jacks and Cables (RCA-type)

The AUDIO/VIDEO jacks provide very good picture quality and mono sound, and can be used if your TV has audio/video input jacks.

These jacks are used for most audio/video connections between components. The VCR AUDIO/VIDEO jacks are color coded (yellow for video and white for audio).

If your TV only has two inputs for audio (stereo), you may need a Y-adaptor to hear sound from both channels.



Audio/Video Jack

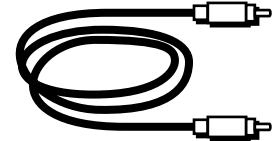

# CONNECTIONS

## CHOOSING A VCR CONNECTION

There are several different ways to connect your VCR, depending on whether or not you have cable service, and if you have a cable box, and whether some of the channels are scrambled, and maybe you have a satellite receiver along with cable (but no cable box), or a satellite receiver and no cable or...well, you get the picture.

Five connections are described in this section and one of them should provide you with a VCR connection that works.

- TV with RF jack only
- TV with audio/video jacks
- TV with audio/video jacks and cable box to unscramble pay channels only

If you need to connect additional components not shown in the diagrams here (and are unsure of how to connect them), refer to the instruction manual that came with that particular component.

## ADVANTAGES OF AUDIO/VIDEO CABLE CONNECTIONS

Using a simple coaxial cable connection gives you good picture quality. If your television has audio/video jacks, I highly recommend using them to get even better picture quality and mono sound when recording and playing back videotapes. These connections give you more convenient operation by not having to share the TV's antenna signal.

## DON'T FORGET ABOUT THE AUTO TV/VCR FEATURE

The TV/VCR switch controls whether the picture signal is coming from the VCR or the TV.

You can change the setting manually by using the TV•VCR button on the remote or you can set the Auto TV/VCR feature to ON when using only the ANT. IN and RF OUT jacks and OFF when using the AUDIO/VIDEO output jacks – so your TV signal is not interrupted when the VCR is turned on.

# CONNECTIONS

## TV WITH RF JACK ONLY

This connection assumes:

- You are connecting antenna, cable, or cable box system.
- Your television has only an RF input jack.

This connection provides:

- Mono sound playback from VCR.
- Record one channel while watching another (except when using a cable box for all channels).

To use this connection, you must have:

- (1) coaxial cable for cable or antenna connection; (2) for cable box.

To connect:

1. Connect cables as shown.
2. Return to *First Things First*, then follow the steps.

## Using This Connection

Tune your TV to channel 3 or 4, whichever one you selected with the 3 CH. 4 switch on the back of the VCR.

Auto TV/VCR Setting:

- Set the Auto TV/VCR feature to ON.

To play a tape:

1. Insert a tape.
2. If necessary, press PLAY.

To record one program and watch another:

1. Begin recording a program using one of the recording features.
2. Press the TV•VCR button and select a different channel on the TV.

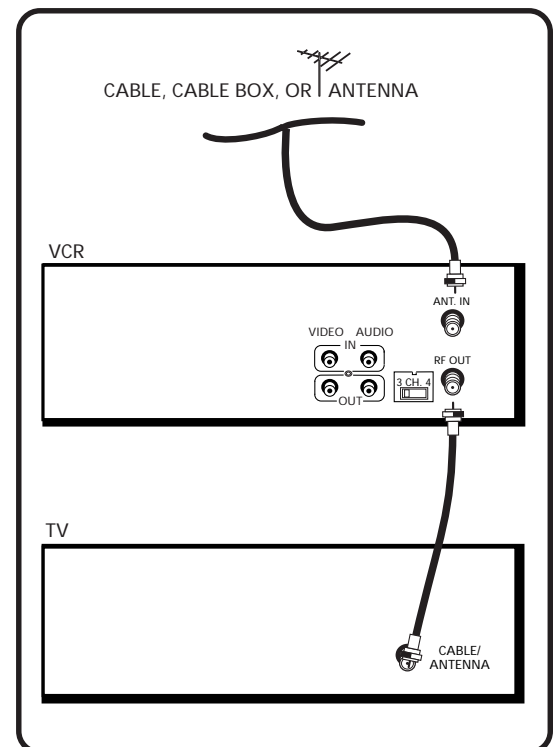



# CONNECTIONS

## TV WITH AUDIO/VIDEO JACKS

This connection assumes:

- You are connecting an antenna, cable, or cable box system.
- Your television has audio/video jacks.

This connection provides:

- Mono sound playback from VCR.
- Record one channel while watching another (except when using a cable box for all channels).

To use this connection, you must have:

- (1) coaxial cable for cable/antenna connection; (2) for cable box
- (2) audio/video cables

To connect:

1. Connect cables as shown.
2. Return to *First Things First*, then follow the steps.

## Using This Connection

Tune your TV to its video input channel. Use of TV•VCR button is not required.

Auto TV/VCR Setting:

- Set the Auto TV/VCR feature to OFF.

To play a tape:

1. Insert a tape.
2. If necessary, press PLAY.

To record one program and watch another:

1. Begin recording a program using one of the recording features.
2. Select a different channel on the TV.

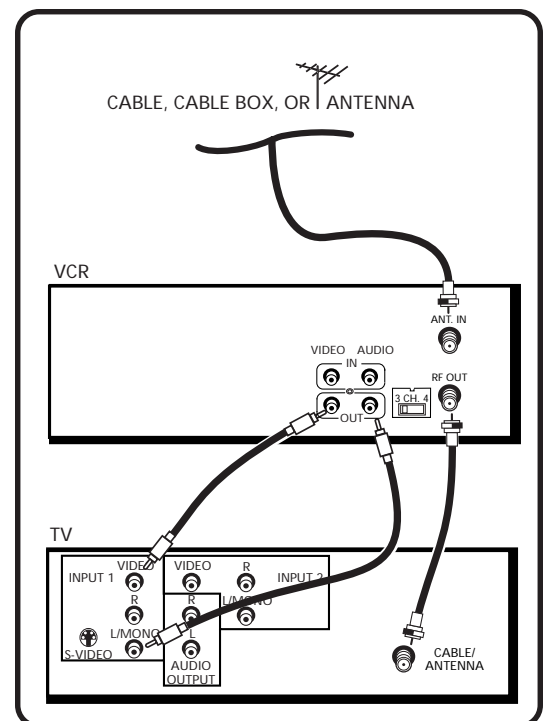

# CONNECTIONS

## TV WITH AUDIO/VIDEO JACKS AND CABLE BOX TO UNSCRAMBLE PAY CHANNELS ONLY

This connection assumes:

- You are using a cable box only to unscramble premium channels.
- Your TV has audio/video input jacks.

This connection provides:

- Mono sound playback from VCR.
- Recording a scrambled or unscrambled channel through the cable box while watching an unscrambled channel.

To use this connection, you must have:

- (3) coaxial cables
- (2) audio/video cables
- (1) splitter

To connect:

1. Connect cables as shown.
2. Return to *First Things First*, then follow the steps.

### Using This Connection

Tune your TV to its video input channel. Use of TV•VCR button is not required.

Auto TV/VCR Setting:

- Set the Auto TV/VCR feature to OFF.

To play a tape:

1. Insert a tape.
2. If necessary, press PLAY.

To record a scrambled or unscrambled program and watch another unscrambled program:

1. Begin recording a scrambled or unscrambled program through the cable box using one of the recording features.
2. Select an unscrambled channel on the TV.

All scrambled channels must be viewed through the VCR.

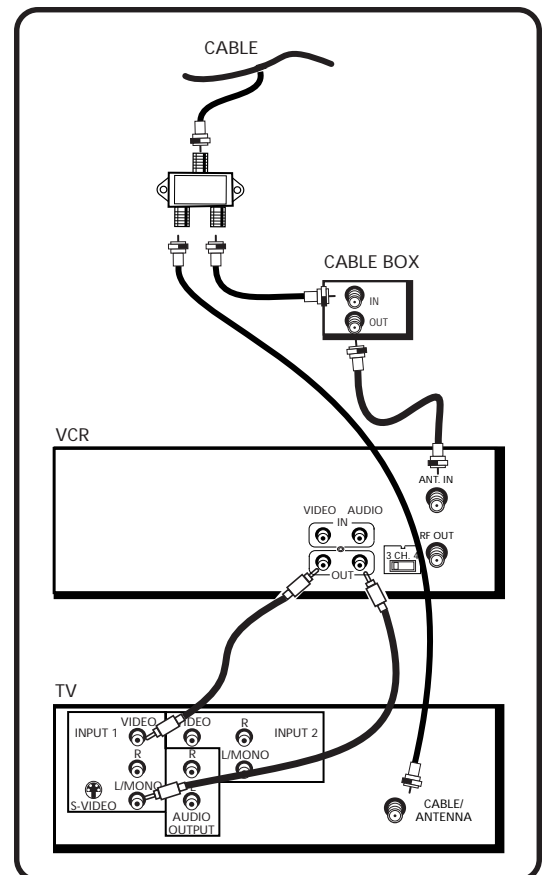

# APPENDIX: REFERENCE

This section gives you some additional information about the VCR, including a description of the unit's controls and display.

You also will find a *Troubleshooting Tips* section in this Appendix, which might help to resolve some of those simple problems.

Finally, this section contains your warranty information.

# APPENDIX: REFERENCE

## FRONT PANEL

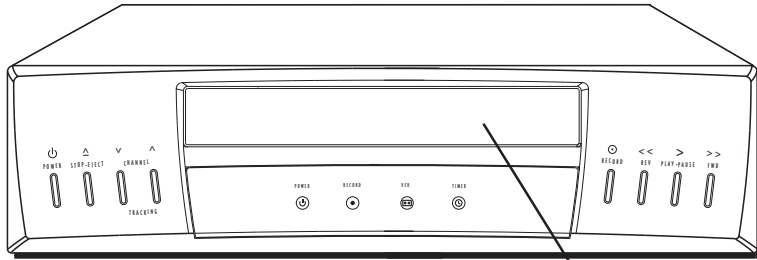

Remote Sensor

**CHANNEL/TRACKING Up or Down** Selects next higher or lower channel in the VCR's channel memory. Adjusts tracking when a tape is playing. Press both together to recenter tracking.

**FWD** Forwards the tape when the VCR is stopped. Searches the picture forward during playback. Starts slow-motion during play-pause and increases slow-motion speed.

**PLAY•PAUSE** Plays a tape. Pauses action for viewing during playback. Pauses recording to prevent recording of unwanted scenes.

**POWER** Turns the VCR on or off.

**RECORD** Starts VCR recording. Used for express recording.

**Remote Sensor** Receives signals from the remote control. Aim the remote at this sensor.

**REV** Rewinds the tape when the VCR is stopped. Searches the picture in reverse during playback. Starts slow motion during play-pause and decreases slow-motion speed.

**STOP•EJECT** Stops the normal functions such as record, playback, rewind, fast-forward, or pause. Ejects the tape when the VCR is stopped.

# APPENDIX: REFERENCE

## INDICATOR PANEL

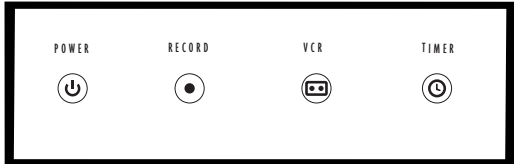

**POWER indicator** Lights when the VCR is turned on.

**RECORD indicator** Lights when the VCR is recording.

**TIMER indicator** Lights during express recording and when VCR is turned off and set for timer recording. Flashes when timer recording is set and there is no cassette in the VCR. Also flashes when clock has not been set.

**VCR Indicator** (Applies only if the VCR Viewing Channel is 3 or 4). Press the TV•VCR button to turn on or off.

- VCR indicator on: Picture from VCR.
- VCR indicator off: Picture from TV channel.

## BACK PANEL

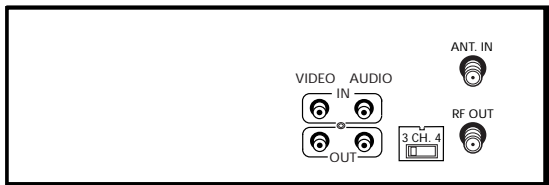

**3 CH. 4 Switch** Selects the channel to which you will tune the TV to see the VCR picture if you connect the VCR using one of the basic hookups.

**AUDIO and VIDEO IN Jacks** Receives signals from another component, like a VCR or camcorder, when it is connected to these jacks. Use INPUT on the remote to select "L" to record from these jacks.

**AUDIO and VIDEO OUT Jacks** Sends signals from VCR to another component, like a TV or VCR, when it is connected to these jacks.

**ANT. IN Jack** Receives a signal from an antenna or cable system when attached.

**RF OUT Jack** Passes signal to TV using the cable supplied.

# APPENDIX: REFERENCE

## TROUBLESHOOTING TIPS

### No power

- Check to make sure it is plugged into an operating outlet.
- Check to make sure your connections are correct.

### VCR does not respond to remote

- Press VCR to set remote to control the VCR.
- Check to make sure there are no objects between the VCR and remote.
- The batteries may need changing.
- Make sure the Remote VCR1/VCR2 setting is set to VCR1 so the remote that came packed with your VCR can operate it.

### Poor or no picture for normal TV viewing

- Check to make sure the VCR indicator is off.
- Check to make sure the TV is switched to an active channel.
- Check to make sure the antenna connections are secure and correct.

### Snowy or no picture during playback

- Press TV•VCR to turn VCR indicator on.
- Check TV channel selected (3 or 4) to make sure it matches the channel selected with 3 CH. 4 switch on back of VCR.
- Check to make sure the TV's fine tuning is correct for the channel you have selected.
- Check video cable connections between VCR and TV monitor.
- Check to make sure the TV monitor is set to video input.
- Try another tape.
- Some snow/streaks are normal during search, stop action, frame advance, and slow-motion playback.

### Streaks in picture during normal playback

- Press one of the TRACKING buttons to move streaks up or down for the best picture.
- Check to make sure the tape is of good quality and not worn out.

### Time counter not working or time counter not working in search modes

- The time counter does not advance during unrecorded portions of tape. When an unrecorded segment of tape is encountered, the time counter will hold its count until recorded material is detected again.
- A minus (-) will appear in front of the time if you rewind the tape farther back than a counter reading of 0:00:00.
- The time counter disappears during search; this is normal.

# APPENDIX: REFERENCE

## Will not record or play

- Check to make sure there is a tape in the VCR.
- Try ejecting and reinserting the cassette.
- Check to make sure the tape is not broken.
- Check to make sure the VCR is not in pause mode. Press PAUSE or PLAY to return to normal playback.
- Check the ProTect Plus™ feature.

## Rewind does not operate

- Check to make sure the tape is not already rewound.

## VCR Plus+ or timer recording not made or wrong program recorded

- Check to make sure the correct VCR Plus+ code is entered.
- Check to make sure the cable box or satellite receiver was turned on when recording was to begin.
- Check to make sure the program was entered correctly (wrong channel or times).
- Power interruption. Reset the clock.
- Check to see if time and date are correct – including AM/PM.
- Check to make sure the program did not exceed the tape's length or the tape was not rewound beforehand.
- Check to make sure the VCR was turned off at the time recording was to start.
- Check to make sure there was a tape in the VCR and the cassette's safety tab was intact.
- VCR ejects cassette when the end of the tape is reached during a timer recording.
- Check to make sure VCR Plus+ setup was completed correctly.

## Will not record

- Check to make sure the safety tab is intact.
- Check to make sure the VCR is not in the line mode. Press INPUT on the remote.

## Internal clock shows incorrect time or date

- Power interruption.
- Check to make sure the clock is set accurately (check AM/PM and date).
- Check Daylight-Saving setting. The clock may have adjusted for daylight-saving time.

## Time did not adjust for daylight-saving time

- Check to make sure daylight-saving feature is set correctly.

## VCR makes noise when stopped

- VCR is removing tape from heads. This is normal. The head cylinder inside the VCR will continue to rotate for a few minutes after you put the VCR in the stop mode.

# APPENDIX: REFERENCE

## **Will not AUTO CHANNEL SEARCH active channels correctly**

- Check to make sure the antenna connections are secure and correct.
- Check to make sure the Signal Type: CABLE/ANTENNA feature is set correctly.
- If Detect Automatically was selected for the Signal Type in the AUTO CHANNEL SEARCH menu, try using either CABLE TV or ANTENNA instead.
- May not be necessary if using a cable box for all channels. Contact your local cable company for more information.

## **Tape plays back in slow motion**

- Press PLAY to return to normal playback.

## **Cannot select channels over 69**

- Cable channels over 69 can only be selected if Signal Type: CABLE/ANTENNA feature is set to CABLE.

## **Cassette with safety tab removed does not start to play automatically**

- Check to make sure the Auto Play ON/OFF feature is set to ON.

## **TIMER indicator flashes**

- Clock is not set.
- Check to make sure there is a cassette in the VCR when a timer recording is set.
- TIMER and RECORD indicators flash when the ProTect Plus™ Locking feature is activated.

## **Time counter disappears during searching**

- This is normal.

## **On-screen menus appear in English, French, or Spanish**

- Check LANGUAGE feature.



# APPENDIX: REFERENCE

## SPECIFICATIONS

<b>Format:</b>	VHS
<b>Record/Playback System:</b>	Video: 4-head Audio: Mono record/playback system
<b>Video Signal System:</b>	EIA standard: NTSC color
<b>Antenna:</b>	75-ohm external VHF/UHF combined antenna terminal
<b>Tuner:</b>	USA: 181 channels capability* (125 cable channels)  Canada: 178 channels capability* (122 cable channels)
<b>Type:</b>	AutoProgramming frequency synthesis
<b>Power Requirement:</b>	120V AC, 60 Hz
<b>Power Consumption:</b>	17 watts
<b>Dimensions:</b>	3.54 inches high (90 mm) 14.1 inches wide (360 mm) 10.9 inches deep (273 mm)
<b>Weight:</b>	7.92 pounds (3.7 kg)
<b>Storage Temperature Range:</b>	- 22°F to +149°F (-30°C to +65°C)
<b>Operating Temperature Range:</b>	+41°F to +104°F (+5°C to +40°C)

\*Check your cable company's compatibility requirements.

## CLEANING THE VCR

Use a soft cloth or dusting attachment of your vacuum cleaner to dust your VCR. Remove dust from the ventilation holes on the top, back, sides, and bottom of the cabinet.

Plastic surfaces are easily scratched and can be marred by alcohol and various solvents. Avoid excessive use of oil-based furniture polishes since the materials used in the cabinet will accumulate more dust. We recommend using a nonabrasive, antistatic cleaner and polisher.

Specifications are subject to change.

# APPENDIX: REFERENCE

## LIMITED WARRANTY

### What your warranty covers:

- Any defect in materials or workmanship.

### For how long after your purchase:

- Ninety days for labor charges.
- One year for parts.

The warranty period for rental units begins with the first rental or 45 days from date of shipment to the rental firm, whichever comes first.

### What we will do:

- Pay any Authorized RCA VCR Service Center the labor charges to repair your VCR.
- Pay any Authorized RCA VCR Service Center for the new or, at our option, refurbished replacement parts required to repair your VCR.

### How you get service:

- Take your VCR to any Authorized RCA VCR Service Center. To identify your nearest Authorized RCA VCR Service Center, ask your dealer, look in the Yellow Pages, or call 1-800-336-1900.
- Show the Authorized Service Center Representative your evidence or purchase date or first rental.
- Pick up your VCR when repairs are completed.

### What your warranty does not cover:

- Customer instruction. (Your Owner's Manual clearly describes how to install, adjust, and operate your VCR. Any additional information should be obtained from your Dealer.)
- Installation and related adjustments.
- Signal reception problems not caused by your VCR.
- Damage from misuse or neglect.
- Cleaning of video/audio heads.
- Batteries.
- A VCR that has been modified or incorporated into other products or is used for institutional or other commercial purposes.
- A VCR purchased or serviced outside the USA.
- Acts of God, such as but not limited to lightning damage.

### Product Registration:

- Please complete and mail the Product Registration Card packed with your VCR. It will make it easier to contact you should it ever be necessary. The return of the card is not required for warranty coverage.

### How state law relates to this warranty:

- This warranty gives you specific legal rights and you also may have other rights that vary from state to state.

### If you purchased your VCR outside the United States:

- This warranty does not apply. Contact your dealer for warranty information.

# APPENDIX: REFERENCE

3 CH.4 switch 5, 43

## A

Accessing menus 5  
Add or remove channels 10  
ANT. IN jack 5, 43  
Audio/video jacks 5, 18, 43  
Auto channel search 9  
Auto play feature 6, 15, 19  
Auto TV/VCR 15, 37  
Automatic rewind 20  
Automatic tracking 19

## B

Back Panel 43  
Basics, learn the 17  
Batteries  
    installing in the remote 4

## C

Cables 36  
    positioning 35  
CHANNEL buttons 18  
Channel List 24  
Channel, VCR viewing 5  
CHANNEL/TRACKING buttons 42  
Channels, add or remove 10  
Channels list, VCR 8  
Choosing a VCR connection 37  
Cleaning the VCR 47  
CLEAR button 18  
Clearing programs 26  
Commercial scan 30  
Connecting your VCR 4, 36  
Connections 35  
    audio/video cable 37  
    TV with audio/video jacks 39

TV with audio/video jacks and cable box to unscramble pay channels only 40  
TV with RF jack only 38  
two VCRs 27  
Copying and editing tapes 27

## D

Date and time setting 11  
Daylight-saving time 10  
Detect Automatically 9

## E

Eject 20  
EnergySaver 16  
Express recording 22

## F

F.ADV button 18  
First setup 3  
Forward and reverse search 30  
Frame advance 31  
Front panel 42  
FWD button 18, 42

## G

GO BACK button 18  
Go-To Search 31, 32

## I

Important information 2  
Index search 32  
Indicator Panel 43  
INFO button 18  
INPUT button 18

# INDEX

## J

Jack

ANT. IN 43

RF OUT 43

Jacks

Audio/video 43

Jacks, types of 36

## L

Language feature 8

Limited warranty 48

Locking feature 32

LP 20

## M

MENU button 5, 18

## N

Number buttons 5, 11, 18

## O

On-screen Displays 34

Overheating 35

## P

PAUSE button 18

Picture search options 30

PLAY button 18

PLAY•PAUSE button 42

Playing a Tape 19

Plugging in the VCR 5

POWER button 20, 42

POWER indicator 43

Power surges 35

Pro-Tect Plus™ Locking Feature 32

Problem solving 44

Product registration 2

## R

REC button 18

RECORD button 42

RECORD indicator 43

Recording 20

copying and editing tapes 27

express 22

timer 23

VCR plus+ 24

XPR 22

Remote

installing batteries 4

Remote Control Option 14

Remote sensor 42

Remote VCR1/VCR2 option 14

Remove or add channels 10

REV button 18, 42

Reviewing programs 26

Rewind, automatic 20

RF OUT jack 5, 43

## S

Safety tab 20

Search

Commercial Scan 30

forward and reverse 30

frame advance 31

Go-To 32

index 32

slow-motion 30

SEARCH button 18

Set time and date manually 11

Set up

first 3

language 8

using menus 8

# INDEX

Set up the VCR 6  
Signal type, changing 10  
SLOW button 18  
Slow-motion search 30  
SLP 20  
Solving problems 44  
SP 20  
Specifications 47  
SPEED button 18  
STOP button 19  
STOP•EJECT button 42  
Stopping a timer recording 26

## T

Tape eject 20  
Tape Speeds 20  
Time and date setting 11  
Time Counter 33  
TIMER indicator 43  
Timer recording 22, 23  
    stopping 26  
    with VCR Plus+ 22  
Tips, troubleshooting 44  
TRACK buttons 19  
Tracking 33  
Troubleshooting tips 44  
TV•VCR button 19

## V

VCR channel list 8  
VCR, cleaning 47  
VCR Indicator 43  
VCR Plus+  
    setting up channels 12  
    worksheet for channels 12  
VCR Plus+ channel list 12  
    Canada 13  
    USA 12  
VCR Plus+ channels 12

VCR Plus+ recording 25  
VCR viewing channel 5

## W

Warranty, limited 48

## X

XPR (express recording) 22

If your VCR needs service, please contact your dealer or the nearest Servicenter from the yellow pages. Please do not send any products to the Indianapolis address listed in this manual or on the carton. This will only add delays in service for your product.

 **THOMSON CONSUMER ELECTRONICS**

10330 North Meridian Street  
Indianapolis, IN 46290

©1998 Thomson Consumer Electronics, Inc.

Trademark(s)® Registered

Marca(s) Registrada(s)

Printed in Japan

TOCOM 15313740 Rev. 1

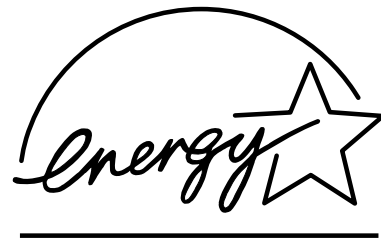

As an ENERGY STAR® Partner, Thomson Consumer Electronics has determined that this product or product model meets the ENERGY STAR® guidelines for energy efficiency.